

Care and
Maintenance
of Renewal by Andersen®
products

Renewal
by Andersen®
WINDOW REPLACEMENT an Andersen Company



Window & Door
Replacement
from a Company
You Can Trust®



Thank you for choosing products and services from Renewal by Andersen

We're confident your new Renewal by Andersen® replacement windows,

patio and storm doors will help make your home more comfortable and energy-efficient year-round. Your new windows and doors have been built and installed to your exact measurements and specifications with the same attention to detail and quality that has made Andersen® products the choice of homeowners, builders, and architects for years.

This booklet shows you how to keep your replacement windows and doors looking and working like new for years of continued enjoyment. Should you run into situations not covered in the following pages, please contact your Renewal by Andersen sales representative or your nearest Renewal by Andersen retailer. You may also call our Warranty Service Line at 1-800-441-1109, visit our website at www.renewalbyandersen.com, or write to:

Renewal by Andersen
9900 Jamaica Avenue
Cottage Grove, MN 55016

Children and window safety

The Consumer Product Safety Commission, in its pamphlet "Protect Your Child," advises: **"Keep children away from open windows to prevent falls. Don't depend on screens to keep the child from falling out of the window. They are designed to keep insects out, not children in. Avoid placing furniture near windows to keep children from climbing to a window seat or sill."** For more information on child safety, call your Renewal by Andersen retailer and ask for our free booklet, "LookOut For Kids."



TABLE OF CONTENTS

Maintaining your windows and patio doors	2
Routine maintenance	3
Product modifications	4
Glass replacement	4
Hardware	4
Corrosion-resistant hardware	5
Hardwood grilles (windows)	5
Understanding condensation	6
General window information	7
Finishing guidelines for windows with Fibrex® material	7
Painting guidelines for windows with Fibrex® material	7
Staining guidelines for wood veneer	9
Painting or staining hardwood grilles	10
Casement windows	10
Awning windows	12
Double-hung windows	13
Gliding windows	17
Picture windows	19
General patio door information	20
Painting and staining guidelines for patio doors	20
Adjusting Andersen® Frenchwood®, Narroline®, and Perma-Shield® gliding patio doors	23
Adjusting Andersen® Frenchwood® hinged patio doors	26
Maintaining your storm and screen doors	30
FullView and MidView storm and screen doors	30
Limited warranty for Renewal by Andersen® products and installation	34

MAINTAINING YOUR WINDOWS AND PATIO DOORS

Proper care and maintenance of your Renewal by Andersen® windows and Andersen® patio doors will help ensure continued operation and lasting beauty.

WARNING

Static created when removing film can ignite flammable materials or cause a shock.

See warning label on glass.



WARNING

Dispose of film immediately after removing. Film may pose suffocation hazard to children.

Film removal

- Remove protective film from seam or corner using a plastic scraper if needed.
- Remove protective film within nine months of installation and when temperature is above 32 degrees.

Renewal by Andersen products come standard with High-Performance™ Low-E4® glass. The glass has a low-maintenance exterior coating and removable protective film on both the interior and exterior glass surfaces to help safeguard against mortar, dirt and dust during shipping and installation. The low maintenance exterior coating is highly durable but can be damaged by scratching with hard objects.

CAUTION

- Sealants will damage exterior coating on glass.

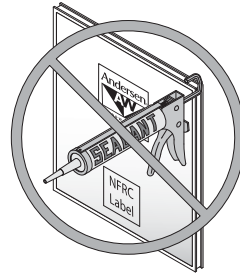

- Do not apply any type of film to insulating glass. Thermal stress and glass damage can result. Shacking devices (insulated coverings, shutters, etc.) may also cause thermal stress and condensation damage.

CAUTION

Metal razor blades can damage glass surface and exterior coating.

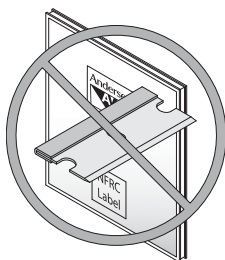

CAUTION

Abrasive cleaners will damage glass surface.

Acid solutions used for cleaning masonry or concrete will damage glass, fasteners, hardware and metal flashing.

Protect unit and follow cleaning product instructions carefully. If acid contacts unit, wash all surfaces with water immediately.

To minimize glass cleaner residue from depositing on the glass, do not clean in direct sunlight.

Do not use newspaper to dry the glass surface as the ink may discolor the surrounding Fibrex® material.

Routine maintenance

- Clean out dirt and debris from sills and tracks to keep your windows and doors opening and closing easily.
- Clean the frame, sash, and grilles by using a mild solution of soap and water and a soft rag or brush. See each window section for detailed washing instructions.
- To clean the glass, first wipe loose dirt and grime from the glass with a soft dry cloth. Apply a cleaning solution such as mild soapy water, vinegar-and-water, or a liquid window cleaner to the glass and wipe in a circular motion. Remove the cleaning solution with a squeegee or clean, lint-free cloth. Rinse with clear water if soap has been used.
- Conventional insect screens and TruScene® insect screens are best cleaned with a soft cloth.
- On casement or awning windows and all patio doors, lubricate all moving parts, such as locks, hinges, operators, and rollers with dry lubricant to maintain ease of operation. **DO NOT** use wet lubricants or harsh abrasive cleaners that will collect dirt or other corrosive particles.
- On gliding window frame or double-hung side covers, use a dry lubricant (Teflon® or silicone) if needed to make operation easier.

Product modifications

You may notice that your Renewal by Andersen® replacement windows look



"Teflon" is a registered trademark of E.I. duPont de Nemours and Company.

and feel different from any other window. That's because the window framing and sash are made of Fibrex® material, a unique structural composite of wood fibers and thermoplastic polymer. Fibrex material has an attractive low-luster finish and is virtually maintenance-free.

Modifying your window or door after installation voids the limited warranty. Please consult with your Renewal by Andersen representative before applying screws into window or sash frame. If you choose to modify your windows make sure screws are never used where they could interfere with operation, weatherstrip systems, or glazing. Damage to window from misplaced screws or product modification is the responsibility of the homeowner and does not imply a product or material failure.



CAUTION

Modifying window or door products after installation voids your manufacturer's warranty. This includes driving nails or screws through the window and door sash and frame.

Never nail through Fibrex® material. Irreparable product damage could result.



Glass replacement

With the exception of our picture window, Renewal by Andersen sash are manufac-



WARNING

Wear safety glasses, goggles, or eye shields and gloves when handling glass. Tape broken glass with duct or filament tape before removal to reduce glass fragmentation. Failure to do so may result in injury.

ured to completely seal the insulated glass in the welded Fibrex® material frame. If the glass is broken, the sash must be replaced. Glass in a picture window may be replaced because picture windows do not have a sash.

To order and schedule a new sash installation, call your Renewal by Andersen retailer and give them the serial identification number printed on your window. See the appropriate window style section for location of this number.

Hardware

Wash hardware using a mild detergent and water solution with a soft cloth. Avoid abrasive cleaners, cloths, or brushes. Climate, location, and exposure to corrosive environments such as industrial areas, pesticides, herbicides, or salts are challenges to your ability to maintain the hardware's beauty and characteristics. Simple routine maintenance will help extend the life of your window and door hardware. Contact a professional hardware restorer for refurbishing hardware.

Oil Rubbed Bronze or Distressed Bronze



CAUTION

DO NOT use or apply harsh chemicals, abrasives and/or cleaners. Product damage could occur.

- Handling and frequent use create the bronze patina that is the hallmark of the oil-rubbed bronze and distressed bronze finishes. Oil rubbed bronze and distressed bronze are “living finishes” with no protective coating. With use, your hands will polish away the darker material exposing the bronze beneath. The appearance of these finishes will vary depending on usage and environmental conditions.
- Occasionally apply light mechanic oil to deepen the color and sheen of the product. Cover metal parts with oil entirely, allow the oil to stand for a few minutes, then gently rub off excess using a clean cloth.

Corrosion-resistant hardware

Renewal by Andersen offers hardware for casement and awning windows, and patio doors that is specially designed to resist corrosion in environments such as seacoasts and heavy-industry areas. If you are interested in this option, contact your Renewal by Andersen representative for information.



Hardwood grilles

Hardwood grilles are available for all Renewal by Andersen® replacement windows, Frenchwood® hinged and gliding patio doors, Perma-Shield® gliding patio doors, and Narroline® gliding patio doors.

Removing and installing the window grille



CAUTION

Leave the grille clips in place. Removal of grille clips may result in damage to the glass, seal, and/or sash frame.



CAUTION

When installing or reinstalling your window grilles on double-hung or gliding windows, make sure the grille is set snugly against the glass on the outer sash so it will not catch and break when the inner sash is operated.

Lift the edge of each grille leg away from the glass at the edge of the sash. Do not remove the grille by pulling on the grille intersections.

To replace the grille, place grille against the glass and press each leg firmly into the grille clips and all along the grille (Fig. 1). Make sure the grille fits snugly against the glass.

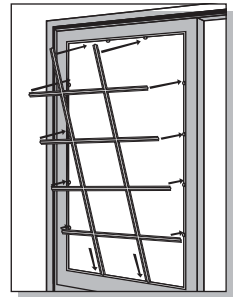

Figure 1, interior view

Understanding condensation

The moisture that suddenly appears in cold weather on the interior or exterior of window and patio door glass can block the view, drip on the floor, or freeze on the glass. It can be an annoying problem. While it may seem natural to blame the windows or doors, interior condensation is really an indication of excess humidity in the home. Exterior condensation, on the other hand, is a form of dew – the glass simply provides a surface on which the moisture can condense.

What are some ways to control interior window condensation? Reduce the indoor relative humidity in living areas, attics, and crawl spaces. The following are a few general suggestions:

- Reduce the amount of moisture you put into the air. This can be accomplished by recognizing the many sources of moisture in the air—from cooking to heating to plants and other items.
- Vent all gas appliances, the clothes dryer, and exhaust fans to the outside. In most climates you should also ventilate your attic and crawl space to the outside. If you have a crawl space it is very important to completely cover the earth with an effective vapor barrier. If you run a humidifier you may need to turn it down or off.
- Drapes and other window coverings can contribute to a condensation problem by restricting the flow of warm room air over the glass surface. Therefore, indoor condensation is more apt to occur when the drapes are closed or the shades are pulled down.
- Make sure you run the exhaust fans in the kitchen when cooking and in the

bathroom when bathing or showering. Run the exhaust fan until the mirror in the bathroom is clear or the temperature near your stove is back to normal. Be careful not to run the exhaust fan too long and overheat the motor.

- Avoid storing firewood in your house or basement.
- For products with the interior insect screen, removing the screen in the winter months when the window is not typically being operated may reduce condensation behind the insect screen by increasing air flow.
- If you have a forced air furnace, make sure your home is properly ventilated by installing a fresh air intake. Or if your home is extremely “tight” and you have excessive moisture, it may be helpful to install an air-to-air heat exchanger.

For more information on the causes of and cures for window condensation, call your Renewal by Andersen retailer and ask for our free booklet, *“A Guide to Understanding Condensation”* or contact the following resources;

National Fenestration Ratings Council (NFRC)

6305 Ivy Lane, Suite 140
Greenbelt, MD 20770
(301) 589-1776
www.nfrc.org

Energy and Environmental Building Association (EEBA)

6520 Edenvale Boulevard, Suite 112
Eden Prairie, MN 55346
952-881-1098
www.eeba.org

GENERAL WINDOW INFORMATION

Finishing guidelines for windows with Fibrex® material

Renewal by Andersen® products come standard with a removable film covering the glass for protection against damage during shipping and installation and to simplify finishing. Use painter's tape around the perimeter of the sash and grilles to further protect the glass surface during finishing. Remove the film only after installation and finishing is complete.

Read and follow finishing product instructions and warnings on finish material.

WARNING

- Use caution when working at elevated heights and around unit openings. Follow manufacturers' instructions for ladders and/or scaffolding. Failure to do so may result in injury or death.



CAUTION

Metal razor blades can damage glass surface and exterior coating.

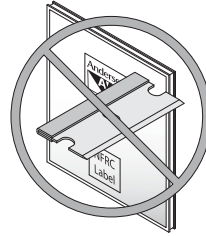

Painting guidelines

Your new windows are manufactured of Fibrex® material with a low-luster Perma-Shield® capping. There is no need to paint the window frame or sash; however, should a change in color be desired please follow these instructions in order to retain warranty coverage.

- **Do not** paint the weatherstrip, gaskets, factory-applied exterior silicone bead, jamb liners, or any surface that has sliding contact with another surface. Also, refer to the section on your particular window style for information on what NOT to paint on that window.
- **Do not** allow painted surfaces to come in contact with other surfaces until thoroughly dry.
- **Do not** paint Cocoa Bean, Dark Bronze or Forest Green colored products.



CAUTION

- Use of stains on Fibrex® material surfaces is not recommended. Stains will cause permanent damage.
- Improper painting can impair proper window operation. Certain solvent-based paints, stains or finishes can also cause permanent damage. If in doubt, contact your Renewal by Andersen representative.
- Do not use ketones (MEK, MIBK) or xylene as a surface conditioner for cleaning the Fibrex material surface.



CAUTION

Do not allow sandpaper or steel wool to contact the glass surface. Scratches or other damage may occur.

If using steel wool, remove all resulting steel fragments immediately to avoid rust stains.

Painting steps

1. Read and follow finishing product instructions and warnings on finish material.
2. Select a high quality, fast-dry alkyd primer (such as KILZ® brand) and an oil or water-based trim paint. Choose an exterior paint for exterior applications and an interior paint for interior applications.
3. Prior to painting, lightly sand the surfaces to be painted with fine sandpaper or steel wool. Remove dust particles with a soft, dry cloth. Surface abrasion helps promote a strong bond between the surface and the paint.
4. Clean the surface of dust and fingerprints with a surface conditioner or mild solvent to promote consistent paint adhesion. Wipe all surfaces with a cloth dampened in surface conditioner or mild solvent, such as acetone, isopropyl (rubbing) alcohol, or denatured alcohol, and allow to dry thoroughly according to manufacturer's instructions.
5. Paint the surface first with a good primer to provide a base for the finish to adhere. Use a fast-dry alkyd primer in a neutral color. Paint the unit with sash open and allow to dry completely before closing (follow the manufacturer's recommendations for dry time).
6. After the primer is thoroughly dry, apply a high quality oil or water based trim paint. Paint exterior surfaces with exterior house paint and interior surfaces with interior paint. Paint the unit with the sash open and allow to dry thoroughly before closing.



"KILZ" is a registered trademark of Masterchem Industries, Inc.

Staining guidelines for wood veneer

The following are recommended guidelines and materials for staining and finishing your new Renewal by Andersen® wood veneer windows. If you plan to stain and finish the windows yourself, we suggest obtaining the materials we recommend from a full service paint and stain dealer. The dealer's experience with the materials will provide guidance to achieve the best results and limit the risks associated with staining and finishing.

Notice: Renewal by Andersen assumes no responsibility for any damage to the windows caused by staining or finishing.

Wood interior staining guidelines

Notice: Stain and finish your new replacement window interiors as soon as possible after installation to prevent marring or discoloring from dust, moisture, or fingerprints.

- Read and follow finishing product instructions and warnings on finish material. **Keep all materials out of reach of children.**
- Perform all staining and finishing instructions, from start to finish, on the natural wood veneered Fibrex® material sample piece before starting on your windows. This will allow you to determine that the stain color and the polyacrylic finish are as desired, and it provides practice in applying the materials to the veneered Fibrex material. If you need more samples, contact your local Renewal by Andersen representative or stop by your local showroom.
- Prepare your work area. Use drop cloths, and have soap and water nearby to wipe away any splatter or spills on floors and furniture. Brief contact with soap and water will not damage the veneered Fibrex® material. Wipe dry with a clean cloth before continuing the staining procedure.
- You are now ready to begin the staining process.

Staining steps

CAUTION

Do not allow sandpaper to contact the glass surface. Scratches or other damage may occur.

1. We recommend the use of a wood conditioner to clean the surface and use of a quality stain for wood and wood veneers. Follow completely the manufacturer's instructions, including any recommended use of pre-stain sealer. (this step is optional, but recommended)**
2. Prior to staining, lightly sand the surfaces to be stained with fine grit sandpaper. Remove dust particles with a soft, dry cloth.
3. Stain the unit with sash open and allow to dry completely before closing or applying the finish coat (follow the manufacturer's recommendations for dry time).
4. After the stain is thoroughly dry, a polyacrylic finish is recommended. Polyacrylic is fast drying and available in a variety of gloss finishes to suit your personal choice. Always follow the manufacturer's instructions on the container label. Apply the finish with the sash open and allow to dry thoroughly before closing.

Materials list

This list specifies materials needed to stain and finish up to eight insert windows or four full-frame windows (including interior casing, trim, and extension jambs), although individual usage may vary.

- Sample piece of Fibrex® material with wood veneer (available from your Renewal by Andersen sales representative)
- Wood conditioner**
- Painter's tape
- Wood stain*

continued...

- Polyacrylic finish*
- Fine grit sanding sponge/block
- Lint-free cloth, approximately 16 inches square
- Wooden stir sticks
- Foam pad applicator or a quality nylon brush

* Choose pint or quart size, depending upon the number of windows and number of coats of stain desired.

Painting or staining hardwood grilles

Your natural wood grilles are unfinished. To paint or stain the grille, remove it from the window or patio door. To assure an even, uniform appearance we recommend that a pre-stain sealer be applied. Apply paint or stain carefully following the manufacturer's instructions. After staining, finish with a high grade seal coat.

Staining wood veneered TruScene® insect screen

To finish the veneer on the TruScene insect screen frame, remove insect screen from the window unit. Using a low adhesive painter's tape, to protect insect screen cloth, tape off screen from edge of insect screen frame. To assure an even, uniform appearance we recommend that a pre-stain sealer be applied. Apply stain carefully following the manufacturer's instructions. After staining, finish with a high grade seal coat. Allow finish to dry thoroughly before placing insect screen in window unit.

Casement and Fixed Windows

WARNING

- Do not leave casement windows open in high winds. Sash blow out may occur in extreme conditions resulting in personal injury and/or product damage.
- Do not permanently remove handles. They must be in place and tightened to allow egress in case of an emergency.
- Use extreme caution when working around window and door openings. Never leave an open window unattended, especially when children are present. Falling from window may result in serious injury or death.

Removing the insect screen

Your insect screen features a strong Perma-Clean® aluminum frame with a glass fiber, aluminum, or TruScene® insect screen.

To remove, unlock the wing-blade fastener on both sides and lift insect screen from the opening.

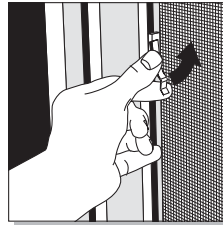

Unlatch the wing-blade fastener

To reinstall the insect screen, reverse the procedure. Be sure to latch it completely.

Washing the window

The hardware design of the casement window lets you wash the exterior surface of the sash from inside.

Notice: windows with egress hinges and very wide casement windows (30-40 inches) may exceed your reach and may need to be washed from the exterior.



To remove grilles for interior cleaning, see page 3.

To clean the exterior, open the window fully and reach between the frame and sash.

Repair or replacement

For product repair or replacement, simply call your local Renewal by Andersen® retailer and give them your window's serial number printed on the window's identification label. The label on a casement is located on the hinged side of the frame; open the sash to view the label.

If you are unable to contact a local Renewal by Andersen retailer, call our national service number located on the window's iden-



Window identification label and serial number

Notice: Do not remove the identification label. It is essential for identifying your specific window if replacement or repair parts are ever needed.

tification label.

Simple adjustments

If the operator handle should slip off or become loose, make sure it is seated properly and tighten the set screw. Make sure the handle is slightly above the cover to avoid interference during operation. Do not leave handles and set screws loose as this may cause stripping of the handle/shaft connections.

Painting or staining

Before painting or staining, thoroughly read all general painting/staining instructions for cautions and recommendations (see pages 7-10). Failure to do so may result in poor appearance or damage to your windows and doors.

DO NOT PAINT:



Weatherstrip - Exterior view

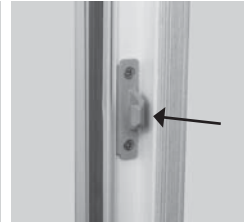

Lock keeper - Exterior view



Lock handle and bezel
- Interior view

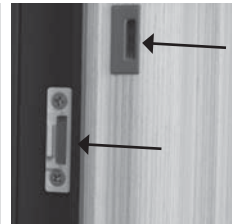

Screen grommet and snigger
- Exterior view

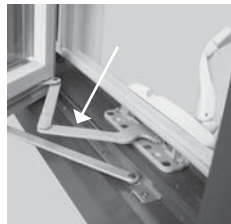

Hinges - Exterior view



Operator handle and cover
- Interior view

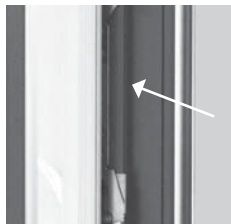

Lock bar - Exterior view

Awning windows

Removing the insect screen

Your insect screen features a strong aluminum frame with a Perma-Clean® glass fiber, aluminum, or TruScene® insect screen. To remove, unlock the latches at the sides and lift the insect screen from the opening. You may need to apply slight pressure so the insect screen flexes to pass by the window's lock levers. To reinstall, reverse the procedure and latch it completely.

Washing the window

The exterior on the awning window must be washed from the outside.

To remove grilles for interior cleaning, see page 5.

Painting or staining

Before painting or staining your awning window, thoroughly read and follow all general painting/staining instructions for cautions and recommendations (see pages 7-10). Failure to do so may result in poor appearance or damage to your windows.

Repair or replacement

For product repair or replacement, simply call your local Renewal by Andersen retailer and give them your window's serial number printed on the window's identification label. The label on an awning window is visible on the top of the frame when the sash is in an open position.

If you are unable to contact a local Renewal by Andersen retailer, call our national service number located on the window's identification label.



Window identification label and serial number

Notice: Do not remove the identification label. It is essential for identifying your specific window if replacement or repair parts are ever needed.

DO NOT PAINT:

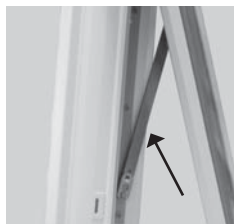

Hinges - Interior view



Weatherstrip - Exterior view



Lock handle and bezel
- Interior view



Lock mechanism
- Exterior view

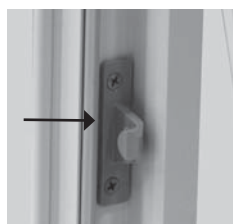

Lock keeper - Exterior view

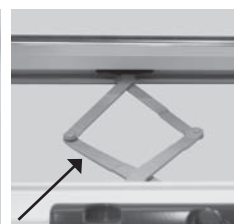

Operator arms - Interior view



Operator handle and cover
- Interior view

Double-hung windows

Removing the insect screen

Your insect screen features a strong aluminum frame with a Perma-Clean® glass fiber, aluminum, or TruScene® insect screen. The insect screen has a center bar and lower latches for increased strength and rigidity. Some taller double-hung windows will have two sets of latches.

Notice: Grip the insect screen tightly to avoid dropping it to the ground outside. Turn it slightly and bring inside.

To remove insect screen, fully open the bottom sash. Release the latches at the lower edges of the insect screen, push the insect screen out to clear the sill and remove from the head channel.

To reinstall, reverse the procedure. Make sure the insect screen is positioned within the screen channel at the top of the window. Be certain to latch it completely.

Washing the window

To remove grilles for interior cleaning, see page 5. Renewal by Andersen® double-hung windows have concealed tilt mechanisms on both sides of each sash. To tilt open and clean both the upper and lower sash, retract the tilt mechanisms with the following easy steps.

To tilt open the lower sash

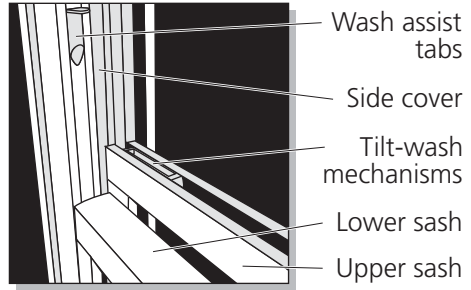

Interior Views

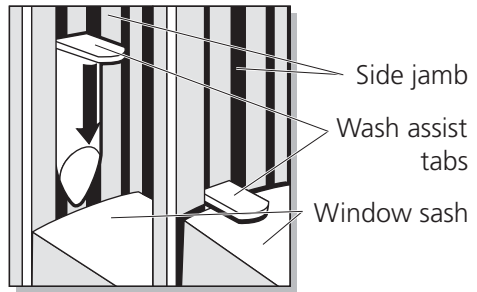

1. Unlock the window and raise lower sash about two inches. Then locate the wash assist tabs along the edge of the frame on each side. Slide the wash assists down until they are wedged between the sash and frame.



Notice: Wash assist tabs are removable.

Interior View



2. Grasp the lower sash with both hands at the outer edges near the wash assist tabs and pull firmly inward. After slight resistance, the sash will pivot inward toward you.

Interior View



3. Continue tilting the sash so that it is supported by the back of a chair or something similar.



To tilt open the upper sash

1. To tilt in the upper sash, the lower sash must be in the tilt-open position. Move the wash assist tabs upward within their grooves until they are at the top of the window frame.

Interior View

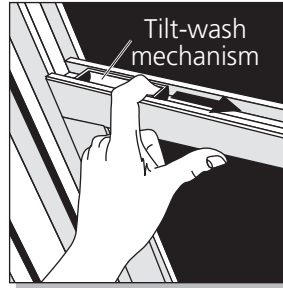

2. Lower the upper sash until you can comfortably reach the tilt-wash mechanisms along the top edge of the sash—leaving at least one inch of space between the upper and lower sash. Grasping the two mechanisms, move the mechanisms toward each other at the center of the window and, at the same time, pull the sash toward you. After a slight resistance the sash will pivot inward toward you.

Interior View

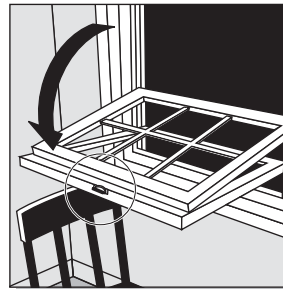

3. Continue the pivot inward until the sash rests against the already-tilted lower sash, and clean it as you cleaned the lower sash.

To close tilted sash

1. Beginning with the **upper sash**, lift the sash from its lowered position until it snaps back into a completely vertical position. Then push upper sash **DOWN** about one inch **BEFORE** sliding to top of frame.
2. Lift the **lower sash** from its lowered position until the sash snaps back into a completely vertical position. Then push lower sash **DOWN** about one inch **BEFORE** sliding to top of frame.

WARNING

If each sash is not reengaged in the track by first pushing **DOWN** about one inch **BEFORE** sliding up in the frame, window will quickly drop and may cause injury.

3. Lock the window to confirm complete engagement.

WARNING

You must store wash assists in their uppermost position to prevent inadvertent tilting in of the window sash. Failure to do so may result in product damage and/or injury.

Interior View

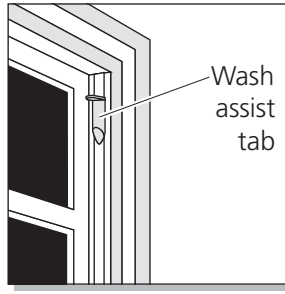

Store wash assist tabs in uppermost position

Repair or replacement

For product repair or replacement, simply call your local Renewal by Andersen® retailer and give them your window's serial number printed on the window's identification label. The label on a double-hung window is located above the upper sash on the top edge of the frame; lower the upper sash to view the label.

If you are unable to contact a local Renewal by Andersen retailer, call our national service number located on the window's identification label.

Notice: Do not remove the identification label. It is essential for identifying your specific window if replacement or repair parts are ever needed.



Window identification label and serial number



Painting or staining

Before painting or staining your double-hung window, thoroughly read and follow all general painting/staining instructions for cautions and recommendations (see pages 7-10). Failure to do so may result in poor appearance or damage to your windows.

It is not necessary to remove the sash when painting. To avoid paint bind, do not paint weatherstripping or the side of sash that touches the side jamb covers.

DO NOT PAINT:



Wash assist tab - Interior view



Check rail weatherstrip
- Exterior view

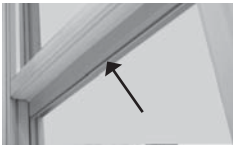

Bottom rail weatherstrip
- Interior view



Sash lift - Interior view



Top rail weatherstrip
- Exterior view



Keeper - Interior view



Sash lock - Interior view



Finger tub - Interior view



Jamb liner - Interior view

Gliding windows

Removing the insect screen

Your insect screen features a strong aluminum frame with Perma-Clean® glass fiber, aluminum, or TruScene® insect screen.

Notice: Grip the insect screen tightly to avoid dropping it to the ground outside. Turn it slightly and bring inside.

To remove, it is advisable to first remove the window sash (see Washing the window). Release the latches in the insect screen side jambs. Push the insect screen outward to clear the sill and remove from the head channel.

To reinstall, reverse the procedure. Be sure to latch it completely.

Washing the window

WARNING

Windows and doors can be heavy. Use safe lifting techniques and a reasonable number of people with enough strength to lift, carry and install window and door products to avoid injury and/or product damage.

WARNING

Use extreme caution when working around window and door openings. Never leave an open window unattended, especially when children are present. Falling from window may result in serious injury or death.

To remove the grilles for interior cleaning, see page 5. The sash on the gliding window can be removed and brought inside for

easy cleaning of the exterior. Simply move each sash, one at a time, to the center of the opening and proceed with the following steps.



Removing the gliding sash - Interior view

Lift the first sash up into the head jamb and pull the bottom of the sash toward you. Repeat with the second sash. After cleaning the window, reverse the steps to replace the sash.



Washing the exterior - Interior view

For large, heavy sash, we recommend removing the insect screens from the exterior. Then, leaving the sash in place, slide from side to side to clean from the interior.

If you have a combination gliding/picture window, the exterior may need to be cleaned from the outside.

Painting or staining

Before painting or staining your gliding window, thoroughly read and follow all general painting/staining instructions for cautions and recommendations (see pages 7-10). Failure to do so may result in poor appearance or damage to your windows.

DO NOT PAINT:



Sash lock - Interior view



Keeper - Interior view

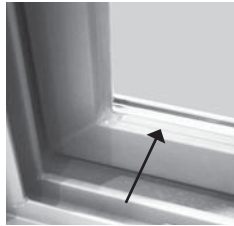

Silicone glazing bead - Exterior view

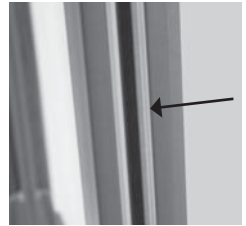

Sash dual leaf weatherstrip - Exterior view

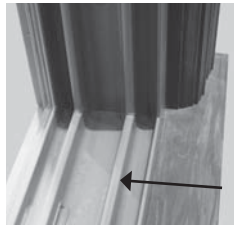

Tracks - Interior view



Repair or replacement

For product repair or replacement, simply call your local Renewal by Andersen® retailer and give them your window's serial number printed on the window's identification label. The label on a gliding window is located on the left side of the head jamb in front of the exterior gliding sash.

If you are unable to contact a local Renewal by Andersen retailer, call our national service number located on the window's identification label.



Window identification label and serial number

Notice: Do not remove the identification label. It is essential for identifying your specific window if replacement or repair parts are ever needed.



Picture windows

Washing the window

The exterior of the picture window must be washed from the outside.

To remove grilles before cleaning the interior glass, see page 5.

Painting or staining

All Fibrex® material surfaces on your picture (fixed) window may be painted. Before painting or staining your picture window, thoroughly read and follow all general painting/staining instructions for cautions and recommendations (see pages 7-10). Failure to do so may result in poor appearance or damage to your windows.

Repair or replacement

For product repair or replacement, simply call your local Renewal by Andersen retailer and give them your window's serial number printed on the window's identification label. The label on a picture window is located beneath the window cover. Removing this cover is not typical for a customer to do. Please call your local Renewal by Andersen showroom for assistance.

If you are unable to contact a local Renewal by Andersen showroom, call our national service number line at 1-800-441-1109.



Window identification label and serial number

Notice: Do not remove the identification label. It is essential for identifying your specific window if replacement or repair parts are ever needed.

GENERAL PATIO DOOR INFORMATION

Painting and staining guidelines for patio doors

For more information visit:
www.andersenwindows.com



CAUTION

Finish wood surfaces immediately after installation. Unfinished wood will deteriorate, discolor, and/or may bow and split. Do not stain or paint weatherstrip, vinyl, glass or hardware. Product damage may occur.

Use a clean cloth or clean plastic scraper to remove paint or staining materials from the glass surface.

Notice: *Renewal by Andersen assumes no responsibility for any damage to the door caused by painting or staining.*

To paint Perma-Shield® patio doors

The entire framework of your Perma-Shield® gliding door is sheathed with rigid vinyl. We recommend that you do not paint or apply other finishes to the vinyl because it may damage the surface.

The Perma-Shield cladding is a low-maintenance surface. If, however, you choose to paint the Perma-Shield cladding surface, please follow the following steps and observe the following guidelines.

Notice: *Read and follow finishing product instructions and warnings on finish material.*

Notice: *Painting Perma-Shield cladding creates a maintainable surface. Periodic Repainting may be necessary.*



CAUTION

White Perma-Shield cladding should only be painted in pastel colors. Do not paint Perma-Shield cladding dark colors.



CAUTION

Metal razor blades can damage glass surface and exterior coating.

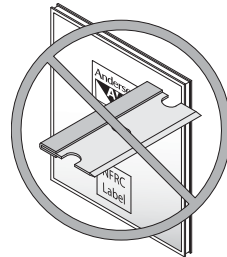

Perma-Shield® cladding must be prepped to accept paint. Use either a liquid sand paper applied by brush, or buff the entire surface with a fine-grade steel wool. Wipe off all residue with a damp cloth and let dry thoroughly.

Apply a high quality oil or water based paint. Two coats may be necessary to cover the original Perma-Shield cladding color.

To paint Andersen® Frenchwood® hinged or gliding patio doors

Notice: The silicone fillet bead on the door panel exteriors will not accept paint. Since the silicone bead is critical to performance of the door panels, we strongly recommend that the silicone bead be left undisturbed.

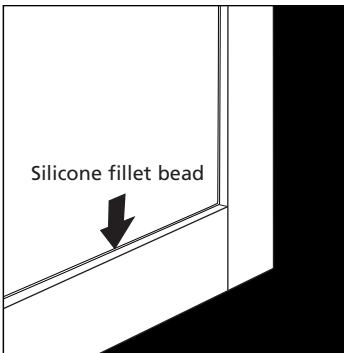

⚠ CAUTION

- Sealants will damage exterior coating on glass.

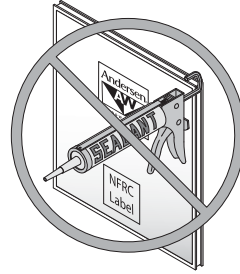

- Do not apply any type of film to insulating glass. Thermal stress and glass damage can result. Shacking devices (insulated coverings, shutters, etc.) may also cause thermal stress and condensation damage.

To paint Andersen® Frenchwood® gliding door exterior frame

Thoroughly wipe all surfaces to be painted with a cloth dampened with acetone. After the acetone dries, apply a high quality oil or water based paint.

To paint Andersen® Frenchwood® gliding door exterior panels

⚠ CAUTION

Do not allow sandpaper or steel wool to contact the glass surface. Scratches or other damage may occur.

Buff all surfaces with a 3M® Scotch Brite® pad, 00 steel wool or 240 grit sandpaper

“3M” and “Scotch Brite” are registered trademarks of 3M Company.

until dull. Then clean the surface to be painted by wiping with a surface conditioner or acetone. After the acetone dries, prime surfaces with a fast-dry alkyd primer in a neutral color. When primer is thoroughly dry (follow manufacturer's recommendations for dry time), apply a high quality oil or water based paint. The operating panel should be removed during painting.

To paint Andersen® Frenchwood® hinged door exterior panels and frame

Buff all surfaces with a 3M® Scotch Brite® pad, 00 steel wool or 240 grit sandpaper until dull. Then clean the surface to be painted by wiping with a surface conditioner or acetone. After the acetone dries, prime surfaces with a fast-dry alkyd primer in a neutral color. When primer is thoroughly dry (follow manufacturer's recommendations for dry time), apply a high quality oil or water based paint. The operating panel should be removed during painting.

To paint or stain interior door wood surfaces

We recommend sanding all door wood surfaces with fine sandpaper or steel wool prior to painting or staining. ***We strongly recommend the use of a pre-stain prior to staining.*** If a pre-stain is not used, a spotty appearance may result.

Any high quality oil based stain, oil based paint or water based paint will work satisfactorily if applied according to the manufacturer's directions. Paint or stain with the operating panel open and do not close until thoroughly dry according to manufacturer's drying instructions. After staining, the wood should be finished with a quality conventional lacquer, varnish, or polyurethane.

Adjusting Andersen® Frenchwood®, Narroline®, and Perma-Shield® gliding patio doors

Removing the insect screen

Your Perma-Clean® insect screen features either stainless steel spring guides or spring-loaded rollers on top and rollers on the bottom.

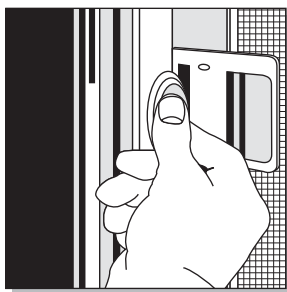

Locking mechanism - Interior view

The insect screen locking mechanism is located on the side jamb of 2-panel patio doors, and on the locking stile of 3-panel patio doors. To remove the insect screen, slide it to the center of the frame, lift and pull out at the bottom.



Insect screen removal from interior or exterior

When replacing the insect screen, be sure to insert the top into the vinyl channel first. Then position the bottom rollers on the sill rib guide. Latch the insect screen completely.

If the insect screen operates stiffly, make sure that the rollers are properly seated on the guide. If the bottom appears to be dragging, insert a flathead screwdriver into the adjusting holes on the inside bottom rail and turn to raise or lower the insect screen. Close the insect screen to within one inch of the side jamb and check for uniform opening from top to bottom.

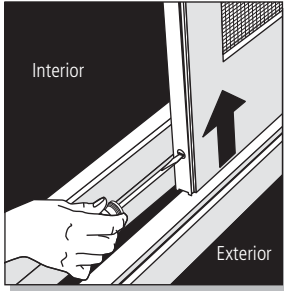

Roller adjustment

Simple adjustments

If the panel operates stiffly, it may be dragging slightly because the patio door is out of adjustment. To adjust it, remove the caps located on the interior bottom rail of door, insert a flathead screwdriver, and turn to raise or lower the rollers. Move one notch at a time, checking door operation as you go.

Close panel to within one inch of the side jamb and check for uniform opening from top to bottom.

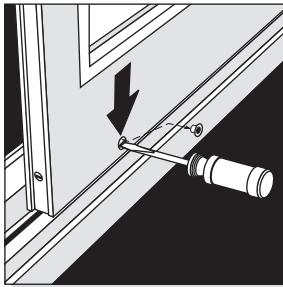

Roller adjustment - Interior view



WARNING

Adjustment hole caps are small parts and, if swallowed, could pose a choking hazard to young children. Replace caps after making adjustments.



Check and adjust lock alignment on 2-panel patio doors

Close operating panel and turn the latch lever to lock position. The latch should engage latch receiver smoothly and pull the panel into the receiver jamb for a snug fit.

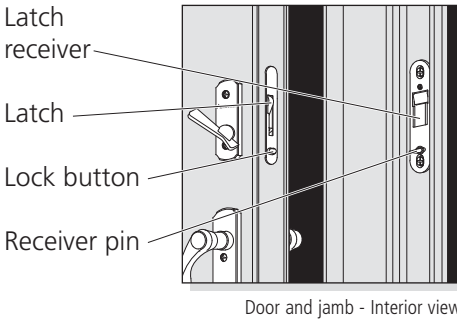
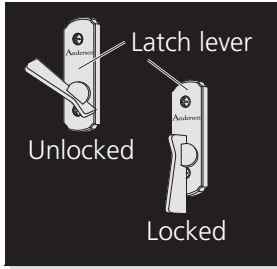

If the latch fails to engage follow these steps:

1. Close the operating panel to check alignment of the lock button to the receiver pin.
2. Loosen the latch receiver screws and move the latch receiver up or down and/or move receiver pin right or left as required.
3. Tighten latch receiver screws when the lock button and the receiver pin are aligned.
4. Adjust the door and frame fit using a small flathead screwdriver to turn the adjustment screw on latch receiver, if necessary.

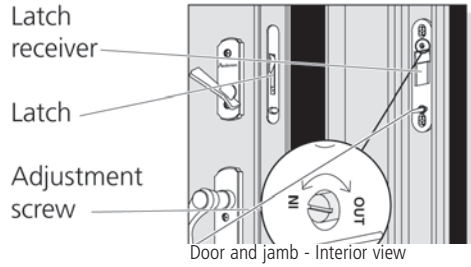

5. If the panel does not fit snug against the weatherstrip, turn adjustment screw on latch receiver counterclockwise toward “IN” position for a tighter fit using a flat-head screwdriver.

6. If the latch lever operates stiffly when locking or unlocking door, turn adjustment screw on the latch receiver clockwise toward “OUT” position for a looser fit using a flathead screwdriver.

Lock adjustment on 4-panel patio doors

Close the panel and turn latch lever to lock position. The latch should engage the receiver smoothly and pull the secondary panel into the primary panel for a snug fit.

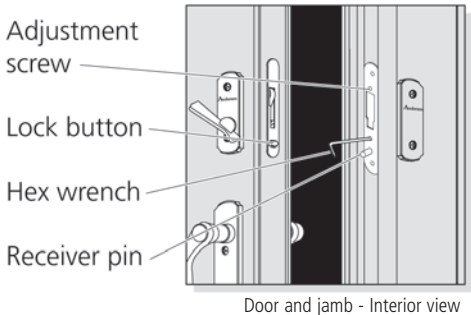
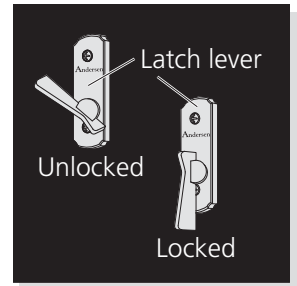

If the latch fails to engage the latch receiver follow these steps:

1. Check alignment of the lock button to the receiver pin on the 4-panel latch receiver.
2. Adjust the receiver pin left or right and/or adjust set screw in the 4-panel latch receiver using a hex wrench. Turn as necessary for correct alignment.

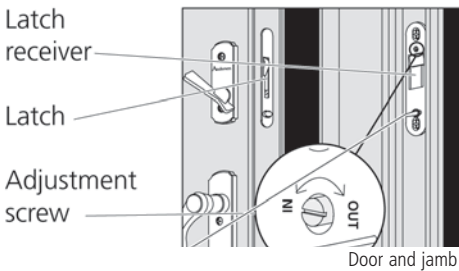

3. Adjust the door and frame fit using a small flathead screwdriver to turn the adjustment screw on latch receiver, if necessary.
4. If the panel does not fit snug against the weatherstrip, turn the adjustment screw on latch receiver counterclockwise toward "IN" position for a tighter fit using a flat-head screwdriver.
5. If latch lever operates stiffly when locking or unlocking the door, turn the adjustment screw on latch receiver clockwise toward "OUT" position for a looser fit using a flathead screwdriver.



Adjusting Andersen® Frenchwood® hinged patio doors

Removing sliding insect screens

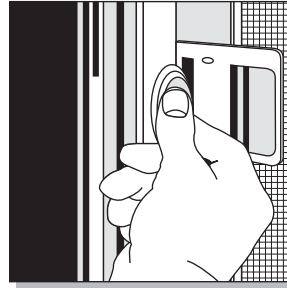

Locking mechanism - Interior view

Your Perma-Clean® insect screen features either stainless-steel spring guides or spring-loaded rollers on top and rollers on the bottom. The insect screen locking mechanism is located on the side jamb of 2-panel patio doors and on the locking stile of 3-panel patio doors.



Insect screen removal from interior or exterior

To remove the insect screen, slide it to the center of the frame, lift and pull out at the bottom.

When replacing the insect screen, be sure to insert the top into the vinyl channel first. Then position bottom rollers on the sill rib guide. Be sure to latch insect screen completely.

If the insect screen operates stiffly, make sure that the rollers are properly seated on the guide.

If the bottom appears to be dragging, insert a flat-head screwdriver into the adjusting holes on the inside bottom rail and turn to raise or lower insect screen.

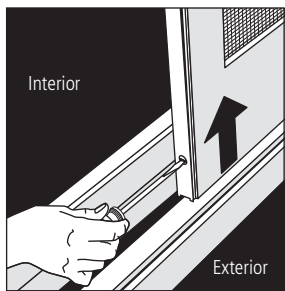

Roller adjustment

Close it to within one inch of the side jamb and check for uniform opening from top to bottom.

Removing the hinged insect screen

To remove the insect screen for cleaning or storage, make sure the surrounding interior or exterior siding or molding does not extend beyond the door frame. Lift off the pins and open the insect screen door about 90 degrees. Lift it up and off its hinges.

Hinged insect screen door adjustments

When making adjustments be sure to place the hold-open washer between the tabs and bracket.

To adjust closing speed turn the actuator screw using a phillips screwdriver. Turn clockwise to slow speed and turn counter-clockwise to increase speed.

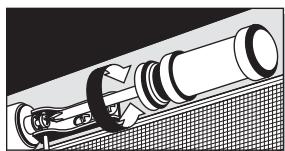

Actuator Screw

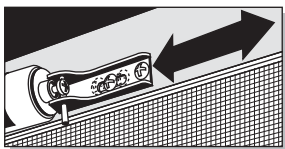

Door Bracket

To adjust closing tightness, move the door bracket left or right.

Hinged patio door adjustments

Settling of your house and a variety of other conditions may require that you adjust your Frenchwood® hinged patio door.

Check the clearance between the frame and the perimeter of the active and passive panel to determine if adjustment is necessary. If the clearance is not equal around the perimeter or there is interference between the panel and the frame, the panel should be adjusted. To determine the method of adjusting, compare the hinge on your door to the illustrations that follow.

The patio door provides for horizontal and vertical adjustments on the hinge. Horizontal adjustment is usually all that is necessary. A 1/2 inch hex wrench is provided with the door for making these adjustments.

As needed, use a light oil to lubricate the hinges.

Horizontal adjustment

(side to side) *Continued next page*

NOTICE

Hinge replacement WILL NOT correct problems resulting from improper door installation. Examples of improper installation include units not being installed plumb, level, and square, excessively bowed jambs, and/or crowned sills.



CAUTION

Do not remove position fixing screws from the hinge. Removal of these screws can cause door to drop or fall and may lead to injury or product damage.

1. Check that gap between panel and hinge side of frame is equal.

2. Correct gap by turning Horizontal Adjusting Screw counterclockwise to move door away from hinge side or clockwise to move door closer to hinge side.

3. Check that gap between panel and frame on latch side and hinge side is equal to the thickness of the 5/32" Hex Wrench.

4. Move all hinges in or out to correct gap and center panel in frame.

Notice: Make all horizontal adjustments first. Horizontal adjustments correct most problems. Vertical adjustments are rarely needed. Horizontal adjustments move panel side to side to square and center panel in opening. Vertical adjustments move panel up and down to center panel in opening.

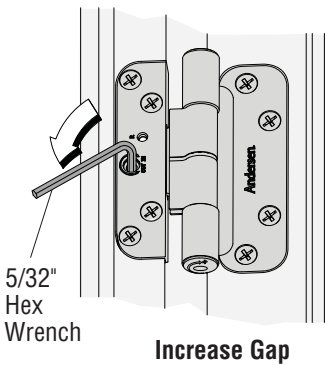
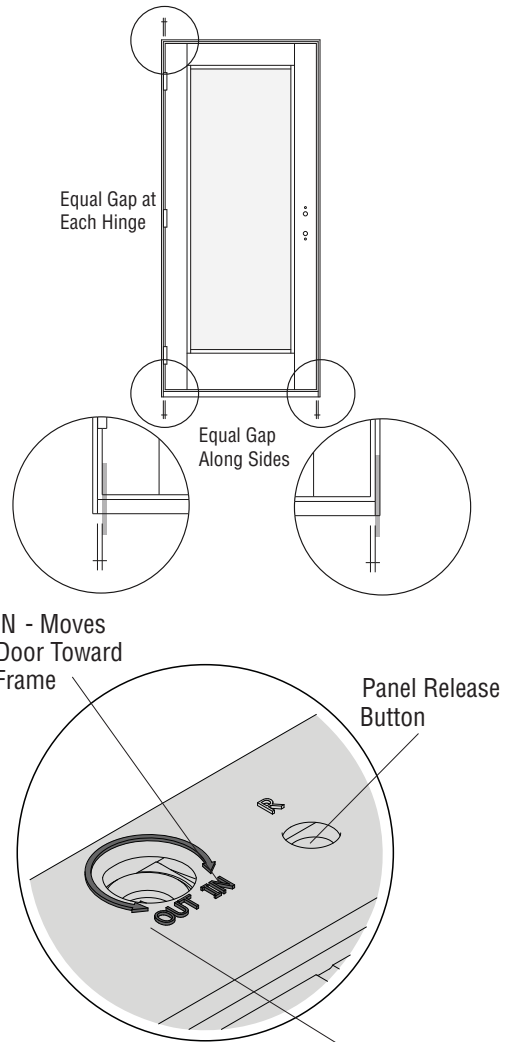

Interior Views

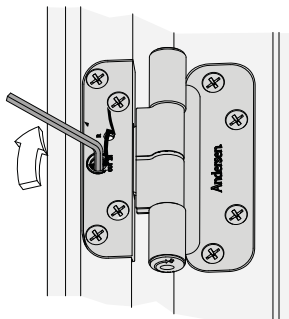

Horizontal Adjustment Screw

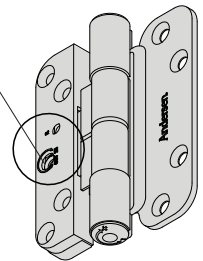

Vertical Adjustment (up and down)



CAUTION

Do not over-tighten vertical adjustment screws. This will cause tight operation and damage to the hinge.

1. Determine if gap between panel and head and sill are equal.
2. Turn bottom hinge Vertical Adjustment

Screw clockwise 1/2 turn and then continue turning until door is centered vertically in opening.

3. Turn next hinge Vertical Adjustment Screw clockwise until door moves slightly, then turn counterclockwise 1/4" turn. Repeat for remaining hinges working upward.

Notice: Adjust hinges with door slightly open. The door should be supported by all hinges to make sure of maximum hinge performance. Start adjustments at bottom hinge and move upward.

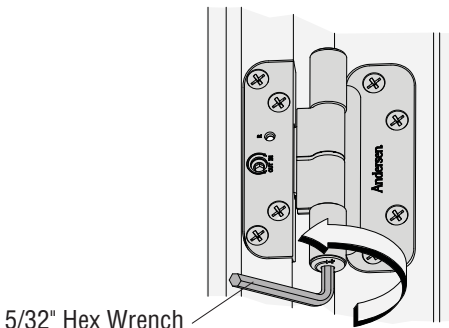
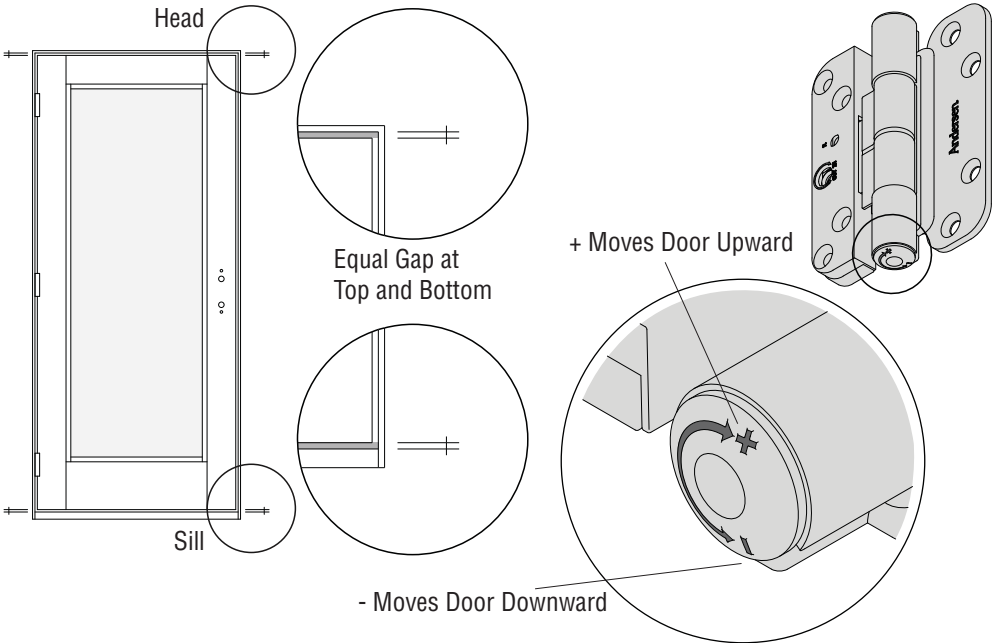

5/32" Hex Wrench

Lower Panel

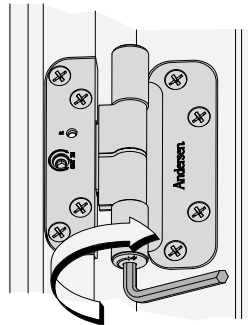

Raise Panel

Interior Views

Adjustments for active/passive or passive/active units only

1. After all hinge adjustments have been made, make a pencil mark where the top of the latch strikes the latch receiver (Fig. 5).
2. Loosen the blocker adjustment screw at bottom of the blocker using a hex wrench. (Fig. 6).
3. Slide blocker up or down so that the lower surface of the blocker lines up with the pencil mark.
4. Tighten the blocker adjustment screw.
5. Close and lock both panels.

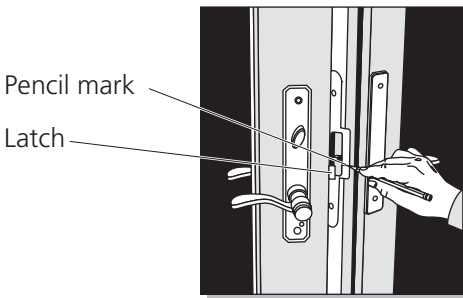

Figure 5 - Interior view

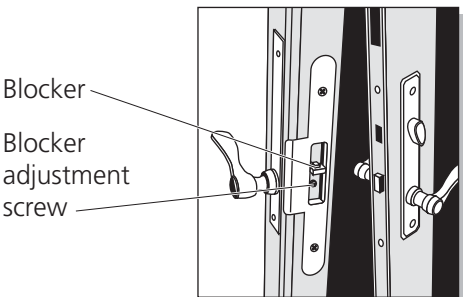

Figure 6 - Interior view



Operating the locking system

Notice: It is important to keep doors locked when not in use to help prevent bowing.

The latch activates automatically as the door is closed. To open the door, push downward on the inside or outside handle (Fig. 7).

The hook bolts may be activated once the active panel is closed by lifting either the inside or outside handle (Fig. 8).

To activate the deadlock, turn the inside latch or use the exterior keyed lock. Hook bolt locks must be in the locked position before the deadlock can be properly locked (Fig. 9).

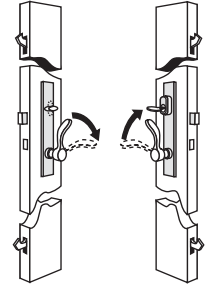

Receiver adjustment

If the locking mechanisms of the hook bolts don't stay in position when locking, use a flathead screwdriver to slightly bend the adjustable tab into the bolt receptacle (Fig. 10).

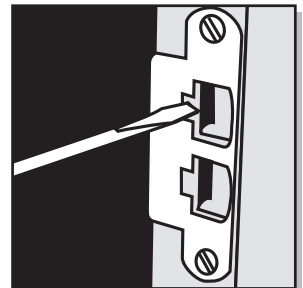
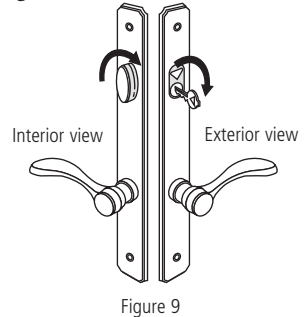

Figure 10

MAINTAINING YOUR STORM AND SCREEN DOORS

FullView and MidView storm and screen doors

General maintenance

For more information visit:
www.stormdoors.com



WARNING

Wear gloves, safety glasses, goggles, or eye shields when handling glass. If broken, glass could fragment and cause injury.



CAUTION

Do not use harsh abrasives or products that contain chlorine. Damage to your door may occur.

Use abrasives with extreme caution. Abrasives that are coarse or require that pressure be applied may dull or irreparably damage door's finish.

Read and follow completely the manufacturer's instructions and product warnings for any product used to clean or enhance the beauty of your storm door.

To maintain the appearance of your FullView or MidView storm door, wash with a mild solution of soap and water twice a year. You may also apply a car wax every one to two years.

Glass – Storm door glass may be cleaned with any household glass cleaner.



Typical FullView Storm Door



FullView TruEase® /TruScene® Storm Door



Typical MidView Storm Door

Plastic parts – Clean plastic door components with a mild solution of soap and water and gently rubbing the affected area.

Aluminum parts – Aluminum parts on the door may be cleaned with a mild solution of soap and water by gently rubbing the affected area.

If soap and water are not effective, try using mineral spirits. Mineral spirits will remove many items such as glue residue and will not harm the paint. You may also use a mild abrasive with light pressure.

Sweep – The finished sweep at the bottom of your storm door may be cleaned with a mild solution of soap and water.

Read and follow completely the manufacturer's instructions and product warnings for any product used to clean or enhance the beauty of your storm door.





CAUTION

Damage may result if products that contain chlorine are used to clean brass. Always read and follow product manufacturer's instructions and warnings.

Brass and Nickel handles – Brass and nickel storm door handles are coated with a clear urethane finish, which protects the brass from tarnishing. Climate, location, and exposure to corrosive environments such as industrial areas, pesticides, herbicides, or salts are contributing factors to your ability to maintain the beauty and luster of the brass finish.

Wash brass handles with a mild detergent and a soft cloth. Avoid abrasive cleaners, cloths, or brushes. Apply a non-abrasive paste wax (S.C. Johnson or Turtle Wax® brands) following manufacturers' directions to protect and restore the brass hardware's luster. **DO NOT** apply harsh chemicals and cleaners such as hydrogen chloride, sodium hyperchlorite, and hydroxyacetic sulfanacide to any brass hardware or clear coat damage could occur.

Oil Rubbed Bronze Handles - Handling and frequent use create the bronze patina that is the hallmark of the oil-rubbed bronze finishes. Oil rubbed bronze is a "living finish" with no protective coating. With use, your hands will polish away the darker material exposing the bronze beneath. The appearance of these finishes will vary depending on usage and environmental conditions.

Occasionally apply light mechanic oil to deepen the color and sheen of the product. Cover metal parts with oil entirely, allow the oil to stand for a few minutes, then gently rub off excess using a clean cloth.

Staining and/or painting storm doors

Read and follow finishing product instructions and warnings on finishing materials.

Your MidView and/or Fullview storm door comes pre-finished and no additional finish is necessary. We do not recommend you paint or stain your storm door.

Renewal by Andersen assumes no responsibility for any damage to the door caused by painting or staining.

Interchanging glass and insect screen on FullView doors



WARNING

Wear gloves, safety glasses, goggles, or eye shields when handling glass. If broken, glass could fragment and cause injury.

1. Unscrew the interior panel clips holding the glass panel or insect screen in place.
2. Carefully remove the panel or insect screen and set it in a safe place. Install the panel or insect screen and tighten the panel clips to hold the panel in place..

Secured position Partially unsecured Unsecured position



"S.C. Johnson" is a registered trademark of S.C. Johnson Company. "Turtle Wax" is a registered trademark of Turtle Wax Inc.

TruEase® door tilting and cleaning

WARNING

Wear gloves, safety glasses, goggles, or eye shields when handling glass. If broken, glass could fragment and cause injury.

WARNING

Make sure window latches are fully engaged in tracks before releasing. Failure to do so can cause window to fall and may lead to injury and/or product damage.

1. Turn Flipaway handle up so it is out of the way (Fig. 1).

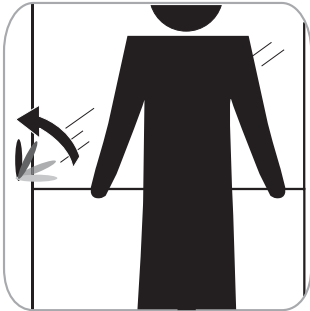

Figure 1

2. Unlock window lock at center of bottom window and raise bottom window approximately three (3) feet from bottom of door. Slide window latches towards center of window (Fig. 2).



Figure 2

3. Tilt bottom window inward. Hold window firmly until supported on a chair or object at 90° angle (parallel to the floor) (Fig. 3).



Figure 3

4. Lower top window down and slide window latches towards center of the window (Fig. 4).



Figure 4

5. Tilt top window inward. Hold securely and wash exterior of window (Fig. 5).



Figure 5

6. After washing, tilt top window back into frame. Make sure latches are engaged in frame. Repeat for bottom window (Fig. 6).



Figure 6

Adjusting the closer(s)

Two (2) closers:

1. Unhook top closer by removing pin that attaches it to the door bracket.
2. Follow steps below for “one (1) closer”.
3. Reattach top closer.
4. Unhook bottom closer by removing the pin that attaches it to the door bracket.
5. Follow steps below for “one (1) closer”.
6. Reattach bottom closer.

One (1) closer:

1. Locate adjustment screw on the end of closer that attaches to the door frame.
2. Open the door, and let it close to note current closing speed.
3. Use Phillips head screwdriver to adjust closer to desired speed (Fig.7).
 - A. For faster closing speed, turn adjustment screw to the left (counterclockwise) (Fig.8).
 - B. For slower closing speed, turn adjustment screw to the right (clockwise) (Fig.8).
 - C. Test door (open it, then let it close) after each adjustment of the screw, and

then adjust screw further (if needed) until desired speed is achieved.

4. (Optional) If more closing power is required, attach door bracket to the inner hole of the closer.

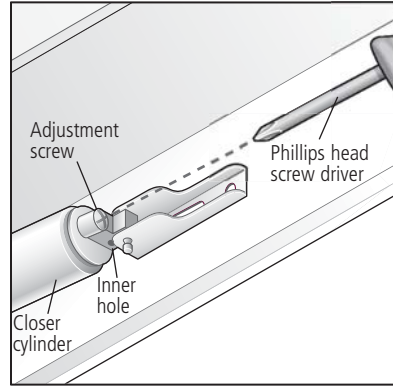

Figure 7

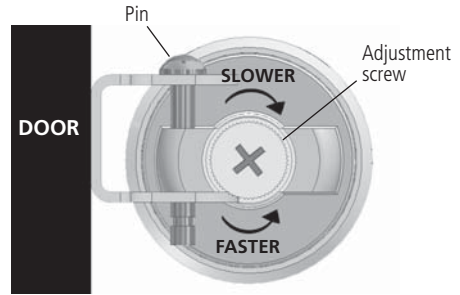

Figure 8
End view of closer



LIMITED WARRANTY FOR RENEWAL BY ANDERSEN® PRODUCTS AND INSTALLATION

Your Renewal by Andersen® products are warranted under a fully transferable limited warranty covering parts, labor, and original installation services as follows:

Twenty (20) year limited warranty for glass

The insulating glass in Renewal by Andersen® window sash and door panels is warranted to be free from defects in manufacturing, materials and workmanship for twenty (20) years from the original installation date. Insulating glass is warranted not to develop, under normal use and conditions, any material obstruction of vision resulting from manufacturing defects or as a result of premature failure of the glass or organic seal. Slight glass curvature and minor scratches or other imperfections in the glass that do not impair structural rigidity or significantly obscure normal vision are not covered by this Limited Warranty.

If your Renewal by Andersen window sash or door panel glass is found to be defective, we may elect to either repair or replace the defective sash or door panel, at no cost to you. Such repairs and replacement parts are warranted for the remainder of the original warranty period.

Two (2) year limited warranty on installation

Installation of your Renewal by Andersen window or door products by an authorized installer is warranted for a period of two (2) years from the date of original installation. During this period, should your Renewal by Andersen window or door fail to perform according to our specifications due to improper original installation, we will bring



the workmanship up to our professional standards, at no cost to you.

This Limited Warranty on installation does not extend to labor/services performed by anyone other than the original authorized installer, nor to the installation or repair of any finishing or other materials that have been applied to or adjacent to the product after the initial installation.

Ten (10) year limited warranty for components other than glass

The frame and sash members of your Renewal by Andersen window are constructed of Fibrex® material. All Fibrex material components of your Renewal by Andersen products are warranted not to flake, rust, blister, peel, crack, pit, corrode, or rot, under normal use, for ten (10) years from the original installation date.

The non-glass components of your Renewal by Andersen windows and doors are warranted to be free from defects in manufacturing, materials and workmanship for a period of ten (10) years from the original installation date. This includes, but may not be limited to, components such as locks, lifts, balance systems, hinges, handles, insect screens and weatherstripping. During the warranty period, we may elect to either repair or replace any defective Renewal by Andersen products or components for you, at no

cost. Such repairs and replacement parts are warranted for the remainder of the original warranty period.

The following sections provide an itemization of conditions and events not covered by this Limited Warranty, and an explanation of how to obtain help under this Limited Warranty.

General conditions and exclusions

The limited warranties set forth in this document are the only express warranties (whether written or oral) applicable to your Renewal by Andersen windows and doors, and no one is authorized to modify or expand these written warranties. All warranty claims must be made during the applicable warranty period.

ALL IMPLIED WARRANTIES INCLUDING MERCHANTABILITY AND FITNESS FOR A PARTICULAR USE WILL EXPIRE WITH THE TIME LIMITS OF THE LIMITED WARRANTY TERMS SET FORTH ABOVE. RENEWAL BY ANDERSEN EXCLUDES AND WILL NOT PAY FOR INCIDENTAL OR CONSEQUENTIAL DAMAGES, AND ITS LIABILITY WILL IN ALL INSTANCES BE LIMITED TO REPAIR OR REPLACEMENT OF THE DEFECTIVE PRODUCT(S), COMPONENT(S), OR INSTALLATION.

Some states and provinces do not allow the exclusion or limitation of incidental or consequential damages, or of how long an implied warranty lasts, so the above limitations or exclusions may not apply to you.

This Limited Warranty is only applicable in the U.S.A. and Canada. This Limited Warranty gives you specific legal rights, and you may have other rights which vary by state or province. See your Renewal by Andersen

representative for warranty coverage of Renewal by Andersen® products purchased or installed outside of the U.S.A. or Canada.

What is not covered by this limited warranty

Some things are not covered by this Limited Warranty such as: damage caused by improper use or maintenance, normal wear and tear, accident, abuse or neglect, acts of God, any painting or staining not performed in accordance with Renewal by Andersen painting or staining guidelines, caulking, except within the installation warranty coverage period; tarnishing or corrosion to hardware finishes except as specifically noted above in this Limited Warranty; fading of colored products due to normal weathering exposure; damage caused by others (e.g., brickwash, use of razor blades, use of sealants, sanding or improper washing); damage due to exposure to conditions beyond published performance specifications; damage to the products caused by water infiltration other than as a result of a defective product or glass; damage due to condensation; damage caused by airborne pollutants such as salt or acid rain; damage caused to the products by use of corrosive cleaning agents or exposure to harsh chemicals; damage caused to the products as a result of settling or structural failure of the structure in which the products are installed; damage as a result of any unauthorized modifications to the products performed after initial installation (e.g., glass tinting, security systems, insulated window coverings, etc.); slight glass curvature and minor scratches or other imperfections in the glass that do not impair structural rigidity or significantly obscure normal vision; or minor warpage of wood and clad wood doors. Andersen may defer actions on any claim for warpage for a period of up to twelve (12) months from the date of the claim in order to permit conditioning and equalization to humidity and temperature conditions. Andersen

does not warrant the performance of the low-maintenance exterior glass coating on products with High-PerformanceLow-E4[®] glass. Performance™ will vary depending on environmental conditions. Installation services by other than authorized Renewal by Andersen installers are not covered.

Special glazings, electric window operators, brass hardware finishes, and Andersen® art glass or decorative glass are not covered under this Limited Warranty. Renewal by Andersen painting and staining instructions are available from your Renewal by Andersen sales representative. All warranties are void if the Renewal by Andersen window or door unit is removed from the structure in which it was originally installed by anyone other than an authorized Renewal by Andersen installer. Also excluded from this Limited Warranty are labor/services and materials to paint or stain any repaired or replaced product, component, trim, finishing or other materials applied to or adjacent to the products, or other carpentry work that may be required. Applicable taxes are also excluded.

Andersen® and EMCO® storm and screen doors have their own limited warranties and are not covered by this limited warranty.

How to get help

To obtain help under this Limited Warranty, contact your sales representative, the nearest Renewal by Andersen® showroom, our Warranty Service Line at 1-800-441-1109

or by visiting our website at www.renewalbyandersen.com

We will contact you to investigate your claim within approximately two weeks after notification, and arrange for appropriate action.

When you call please:

- (a) identify the Renewal by Andersen product or glass that is involved;
- (b) provide the serial number of the affected product (e.g., located on a label affixed to the top or side of the window frame);
- (c) completely describe the problem you have experienced;
- (d) completely describe any attempts that have been made to correct the problem; and
- (e) provide the address where the defective product or glass can be inspected, and your phone number so that we can contact you.

If we are contacted by you within the applicable Limited Warranty period, we will provide the warranted remedies at no charge to you. If your products are beyond the coverage period of this Limited Warranty or if your repairs are not covered by this Limited Warranty, our Renewal by Andersen service representatives can provide repairs, replacement parts or routine maintenance services, should you desire, at a reasonable charge. When warranty coverage is unclear, Renewal by Andersen may charge an inspection fee for any on-site product inspections. If the inspector determines the Renewal by Andersen product has a defect covered by this Limited Warranty, the inspection fee will be waived.

***Thank you for choosing
Renewal by Andersen***

Renewal by Andersen®

WINDOW REPLACEMENT an Andersen Company



"Andersen", "Renewal by Andersen" and the Renewal by Andersen logo are registered trademarks of Andersen Corporation.
All other marks where denoted are marks of Andersen Corporation. © 2011 Andersen Corporation. All rights reserved. 07/2011 Reorder RL-2011

